

CARRON

BATHROOM & INTERIORS *Magazine*

ISSUE 3

The **Wellness Issue**

*Baths, bathing and
a better you.*

News & Trends

Find out what's happening with Carron Bathrooms and the world of bathrooms and interiors.

Healing bubbles

Whirlpool systems bring extra benefits to your bathing. We get into the details of our bespoke systems.

Style Guides

From Monochromatic to Scandinavian. Two simple, understated styles with a very different outcome.

Furry Friends

Our modern living guide has handy hints to help you and your dog get the most from your bathroom.

Carron Bathrooms

Carron Bathrooms is the UK's premier bath manufacturer. Every bath is hand finished to the exacting standards that have been our benchmark since the first Carron works opened in 1759.

GET IN TOUCH

ADDRESS:
Carron Bathrooms Limited
North Carron Works
Stenhouse Rd
Falkirk FK2 8UW
Scotland
United Kingdom

TEL: +44 (0)1324 638 407
EMAIL: info@carronbathrooms.com

FOLLOW US

FACEBOOK: [facebook/carronbathrooms](https://www.facebook.com/carronbathrooms)
TWITTER: [@CarronBathrooms](https://twitter.com/CarronBathrooms)
YOUTUBE: www.youtube.com/CarronbathroomsUK
PINTEREST: uk.pinterest.com/carronbathrooms/

[carronbathrooms.com](https://www.carronbathrooms.com)

Credits

PHOTOGRAPHY
MARK K SEAGER,
GRAHAM WYLIE

DESIGN
SEVENFIVE
CREATIVE

ILLUSTRATIONS
EDWARD MCGOWAN

ON THE COVER

COVER
PHOTOGRAPHY
MARK K SEAGER



carron

Contents

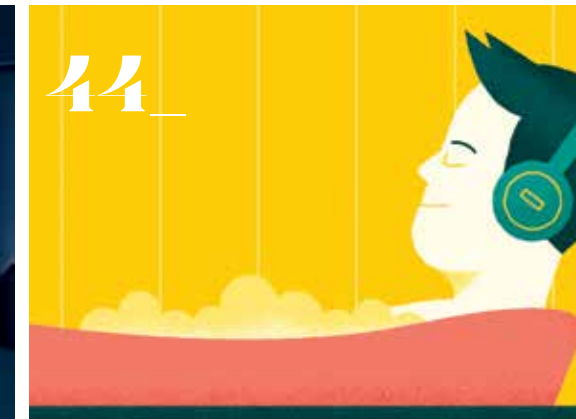

REGULARS

- 05** **Welcome**
A welcome to the third issue from Managing Director, James McMorris.
- 06** **News + Trends**
A range of Carron updates, industry news and interior trends.
- 08** **Modern Life: Furry Friends**
A guide to helping your dog, and you, get the most from your bathroom.
- 10** **Style Guide: Monochromatic**
Simple and striking, this interior style can be easy to implement with maximum effect.
- 22** **Bathing Guide: Plant Life**
Natural, healthy and pretty stylish, too. Check out our helpful guide to bathroom friendly plants.
- 24** **Accessories: Anthracite**
New for 2020, our custom, Anthracite accessories bring a modern, sleek edge to your bath.
- 36** **Modern Life: Fitting In**
When space is at premium or the layout is less than flexible, these space saving baths from Carron could be the answer you are looking for.
- 44** **Bathing Guide: Sports Relief**
As research finds that a warm bath is one of the fastest routes to recovery, we have some tips that will have you back in the gym, or pounding the streets, in no time.
- 50** **FAQs: Cleaning**
Keep your Carron bath looking as good as possible for as long as possible.
- 52** **Style Guide: Scandi Style**
The timeless simplicity of Scandinavian style interiors is the ideal choice for almost any bathroom.
- 58** **ColourMatch**
With Carron's ColourMatch system, we have a colour to match any style.
- 62** **FAQs: Carronite™**
What are the benefits of Carronite? Check our handy guide and find out.
- 64** **Product Range**
Our entire range in a new, easy to view format.
- 70** **Product Focus: Ishga Organic Seaweed**
Innovative skincare products that utilise the natural benefits of organic, Hebridean seaweed.





60

14



FEATURES

14

Celsius Range: **A Guide to Luxury**

When it comes to bathing, it doesn't get much more luxurious than our Celsius range.

26

Cover Feature: **Wellness**

Bathrooms are more than just functional. They can also contribute to your wellbeing and act as an antidote in stressful times.

34

Feature: **The Art of Bathing**

Our guest writer, author Suzanne Duckett, gives us tips and insight on how to get the most from your bath.

38

Feature: **Whirlpool**

If you need to recover from exercise, increase your health and wellbeing or just relax, there's a whirlpool system for you.

46

Supplier Focus: **Laings**

We talk to Darren Walker from Laings, on what it takes to make an award winning showroom and the constant improvement of the customer experience.

56

Supplier Focus: **SpaSplash**

Alan Gape from SpaSplash fills us in on how his route into the world of custom, whirlpool systems was anything but conventional.

60

Feature: **History**

Carron's history has always attracted the attention of the nation. Now, a local group are aiming to bring this history to life.



26

Welcome

Welcome to the third edition of the Carron Magazine, an opportunity for Carron Bathrooms to look beyond technical specifications and into the creative process that inspires our designs and the people who make them a reality.

The theme of this edition is "Wellness". A word that appears more and more in our everyday life, whether it be in diet, exercise, relaxation or mindset. In an age when the pace of change seems to be accelerating, we have tried to stop and reflect on what Wellness actually means. For us it is about time, specifically making more of it for ourselves.

Whether it be 24 hour news stations, social media or the internet, life can seem overwhelming and more and more we are looking for relief, for sanctuary and solitude. With bathing, the immersion of the body in water is a primitive feeling and one that reinvigorates the body, mind and soul. With the addition of whirlpool jets we can turn that water into massage and physical wellbeing.

Don't take my word for it, however. Our guest feature writer, Suzanne Duckett is an authority on wellness and her column is well worth reading.

In our supplier interview, we speak to Alan Gape of SpaSplash products, who has driven innovation in the UK whirlpool industry for over 30 years. His wealth of knowledge has seen him develop tailor-made solutions that allow our customers to take full advantage of the therapeutic power of water.

We also talk with Darren Walker of Laings of Inverurie, about how their award-winning showroom inspires the consumer experience and how a well-designed bathroom layout can make such a difference.

Of course, us humans are not the only ones that enjoy the benefits of a bath. We have featured man's best friend in this issue, and Louis the Cavapoo proved to be the star attraction in our recent Wellness photoshoot.

Our hope is that this year you find some time to relax and enjoy some time for yourself, hopefully in a Carron bath.

JAMES MCMORRINE
MANAGING DIRECTOR

NEWS + TRENDS

The latest news,
industry and bathroom
trends from Carron.

WELLNESS



Wellness: the trend we all need

It has been building for a number of years, but on the back of an increased focus on mental health, the need for wellness has become paramount in our everyday lives. From the workplace to the home, we are all making small steps to improve our mental and physical wellbeing.

Bathing has always been capable of contributing to relaxation and recovery - from sports recovery delivered by whirlpool systems to the simple pleasure of lying in a warm bath after a hard day. Wellbeing is a trend we can get behind, especially if it leaves you healthier and happier.

Back in BLACK

Bathroom design tends to be evolution rather than revolution, and until recently chrome finished brassware, radiators and trims were uniform in a bathroom makeover.

Anthracite accessories, however, have gained increasing prominence in the bathroom, and Carron have worked closely with our UK partners to devise a range of modern handgrips and wastes to ensure that your bath tub synergises with your overall scheme.

Available from Winter 2020, further information is available on [page 24](#) and at [carronbathrooms.com](#)

COLOUR TRENDS



Colour of the Year 2020 Pantone Classic Blue

Following on from 2019's 'Living Coral', Pantone has gone for a more understated hue for the 2020 Pantone Colour of the Year with Classic Blue.

'Instilling calm, confidence and connection' is how Pantone describe Classic Blue. And this style of blue is a favourite of Carron's, too. So much so, we used it as part of our ColourMatch exhibit at the KBB trade show in Birmingham.



If you share your life with a dog, there's a good chance you'll share your bathroom too. So as always, we have some handy tips and hints to make sure you and your furry friend get the most out of your bathroom and hopefully keep your bath in top condition, too.

01.

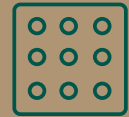

Bath time

Luckily, most dogs love a bath which is good news as they need to be bathed from time to time to ensure basic hygiene as well as keeping their hair and skin as healthy as possible. When bathing your dog it is a good idea to protect the bath surface with a product like the Karlie Bathing Mat ([amazon.co.uk](https://www.amazon.co.uk)) as their claws can inadvertently damage it.

02.



Warm, not hot

Dogs can handle the cold much better than us humans but they still have sensitive skin. Luke warm water is best, so let the water run and test it on your wrist to ensure it isn't too hot. A dog that is uncomfortable is not going to be easy to wash, either.

03.



Lather up

You should never use your own shampoo as they can damage your dog's skin. Most vets recommend using a specialist dog shampoo, specially developed to leave their fur in the best condition while still protecting their skin.

04.



Getting dry

An old cotton towel will get your dog dry but with the amount of water their coats can hold, it's a good idea to get an ultra absorbent towel to help speed things up. Microfibre dog towels ([pawsandpresto.com](https://www.pawsandpresto.com)) can absorb 10 times more water than cotton.

05.



Shake it off

And remember, even after the smallest drop of rain or puddle jump, your pup will want to shake off as much excess water as possible. To keep the majority of the water inside the bath, make sure they are behind the shower screen or curtain when you finish their bath. You have been warned!

**MODERN
LIVING**

FURRY

FRIENDS



MONO CHROMATIC

For a sleek look in the bathroom, you can't go wrong with the understated and minimalist approach of black and white.



“A monochrome colour scheme can be softened with the use of grey towels and accessories. This way you don't lose your black and white styling while adding a more homely touch.”



Getting the Look

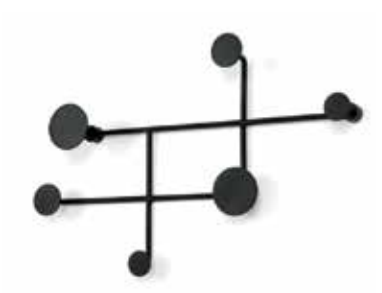

Wall Mounted Towel Hook, Black
made.com



Assorted Towels
marksandspencer.com



Free Standing Towel Rail, Black
made.com



White Bark Cork Tiles
wallsandfloors.co.uk



White Subway Tiles
diy.com



Matte Black Taps
amazon.co.uk

With more and more bathroom fittings and accessories becoming available in black finishes, the monochromatic look can be added in a subtle way that doesn't overwhelm your space or require a full bathroom refit.

Black mirror frames, soap dishes and dispensers will immediately look at home against the white of the bath and white tiles if you have them. Black taps are also an easy place to

start - where you can make impact without having to start your bathroom design from scratch.

A monochrome colour scheme can be softened with the use of grey towels and accessories. This way you don't lose your black and white styling while adding a more homely touch.

Feeling bold? You could go one step further and opt for black walls and floors in your bathroom. 2019 saw 'black bathrooms' appear in

Houzz.com searches for the first time. Would you flip the trend for black on white on its head with black tiles, black framed screens and even black painted walls? It only goes to prove, the monochromatic colour scheme is more flexible than you think.

Anthracite from Carron

To add the finishing touch to your monochromatic interior, how about trying the new Anthracite accessories range from Carron Bathrooms? Find out more about this range of waste, fillers and hand grips in a sleek black finish on pg 24.

Celsius

A Guide to Luxury

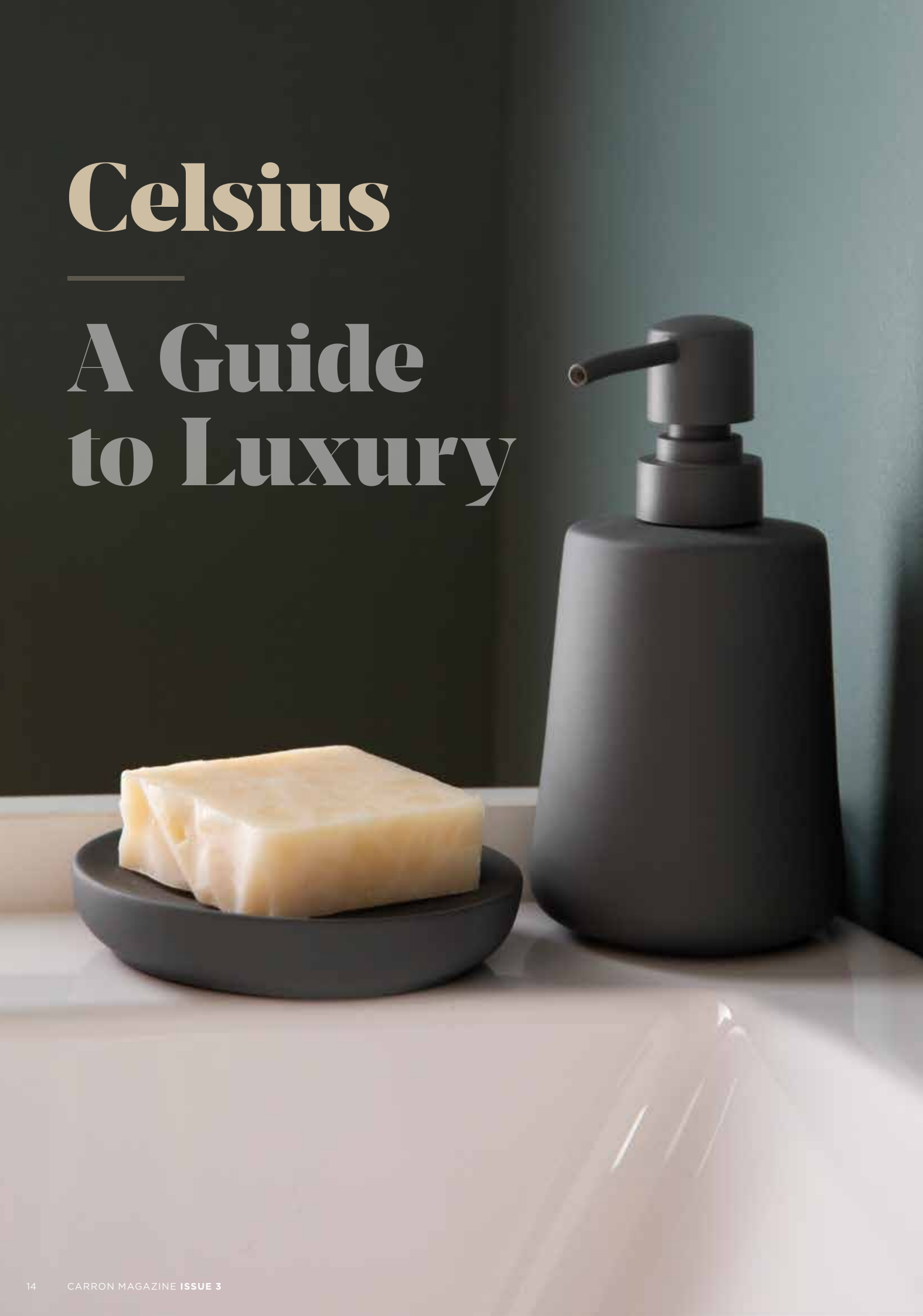



When we created the Celsius range, we did so with one thought in mind. Luxury. This, however, didn't mean we stopped there. These baths still had to contain all the elements that make Carron baths the go-to brand for quality and reliable bathing.

The hidden extra in our Celsius range is our market leading Carronite™ finish. Even if a bath is designed to look beautiful, it should still deliver a an excellent bathing experience. The generous size and smooth design of these tubs is further enhanced by the added strength and rigidity of Carronite™. Throw in increased heat retention for a longer, more relaxing soak and the incredible peace of mind that the 30 year guarantee brings, and you are looking at a quality tub that will be delivering a high-end experience for years to come.



Featured Bath:

CELSIUS 750

Seen here with Anthracite accessories the Celsius 750, brings a touch of class to any modern styled bathroom. The custom designed waste and filler add to the over look and feel. All Celsius baths come with Carronite™ as standard.



Featured Bath:

CELSIUS 1800

The Celsius 1800 is our flagship, wall mounted bath and the last word in functionality and luxury. Deep, wide and very comfortable, this Celsius model turns bathing into an indulgent art. Double ended with centred filler and waste add to the comfort and usability.



Featured Bath:

CELSIUS SHOWERBATH

When you choose a Celsius, you don't have to compromise on practicality. The addition of the showering space on this model creates a bath that provides both comfortable bathing and showering without losing out on the design statement.



Featured Bath:
**CELSIUS
FREESTANDING**

When you want to make a statement, the Celsius Freestanding is the bath for you. The inset filler adds to the sleek design and the tapered, single piece base helps retain an elegant feel while providing a cosy, relaxing bathing sanctuary.



Featured Bath:
CELSIUS OVAL

Perfect for the custom fit bathroom. The Oval, with its half panel, inset design allows this bath to be integrated into your luxury bathroom fit-out. With its generous bathing space and the added luxury of Carronite™ this bath adds individuality into the mix.





Plants don't just make your bathroom look good. They can improve air quality and even increase wellbeing. Here we give you a quick guide to our favourite plants for adding the natural, healthy, touch to your bathroom.

General plant care

Bathrooms can vary from cool to hot and humid so the correct plant choice is essential. Any house plant that does well in a warm, dry space like a living room will not appreciate this type of environment.

With all house plants, try not to over-water them. The soil should be moist, not wet so only water when it feels dry to the touch. Plants appreciate having their foliage cleaned so wiping the foliage down with a damp cloth not only makes them look great but keeps the plant in tip top condition as well.



01

Hedera Helix

English Ivy, Common Ivy

Ideal for smaller bathrooms, English ivy will sit happily in small pots on window ledges and shelves. This gives space for their vines to trail down, putting on a display in your bathroom. Don't let them dry out too much as they rarely recover once the leaves start to die off.

03

Dracaena marginata

Madagascar dragon tree

Although this plant can grow quite tall over time, it's slim leaves never spread out and take up space, making it ideal for sitting in the corner of your bathroom to create interest. Another tough, easy to care for option, the dragon tree will easily recover from neglect.

02

Nephrolepis exaltata

'Bostoniensis' (Boston fern)

This popular fern is easy to care for and tough enough for even the most forgetful of owners. It is ideally suited to the bathroom where it will thrive in the humid conditions. The fronds of this fern can grow to 3 feet long which makes hanging baskets ideal as this will give it space to hang naturally.

04

Ficus Elastica

India rubber tree, rubber plant

If you have the space and are looking for a bathroom plant that will make a statement, the Indian Rubber Tree could be for you. It can grow to 8 ft tall if left to its own devices although will happily stay at around 1-2 ft high if kept pruned and in a smaller pot.

Plant Life

*Great for the mind,
body and bathroom.*

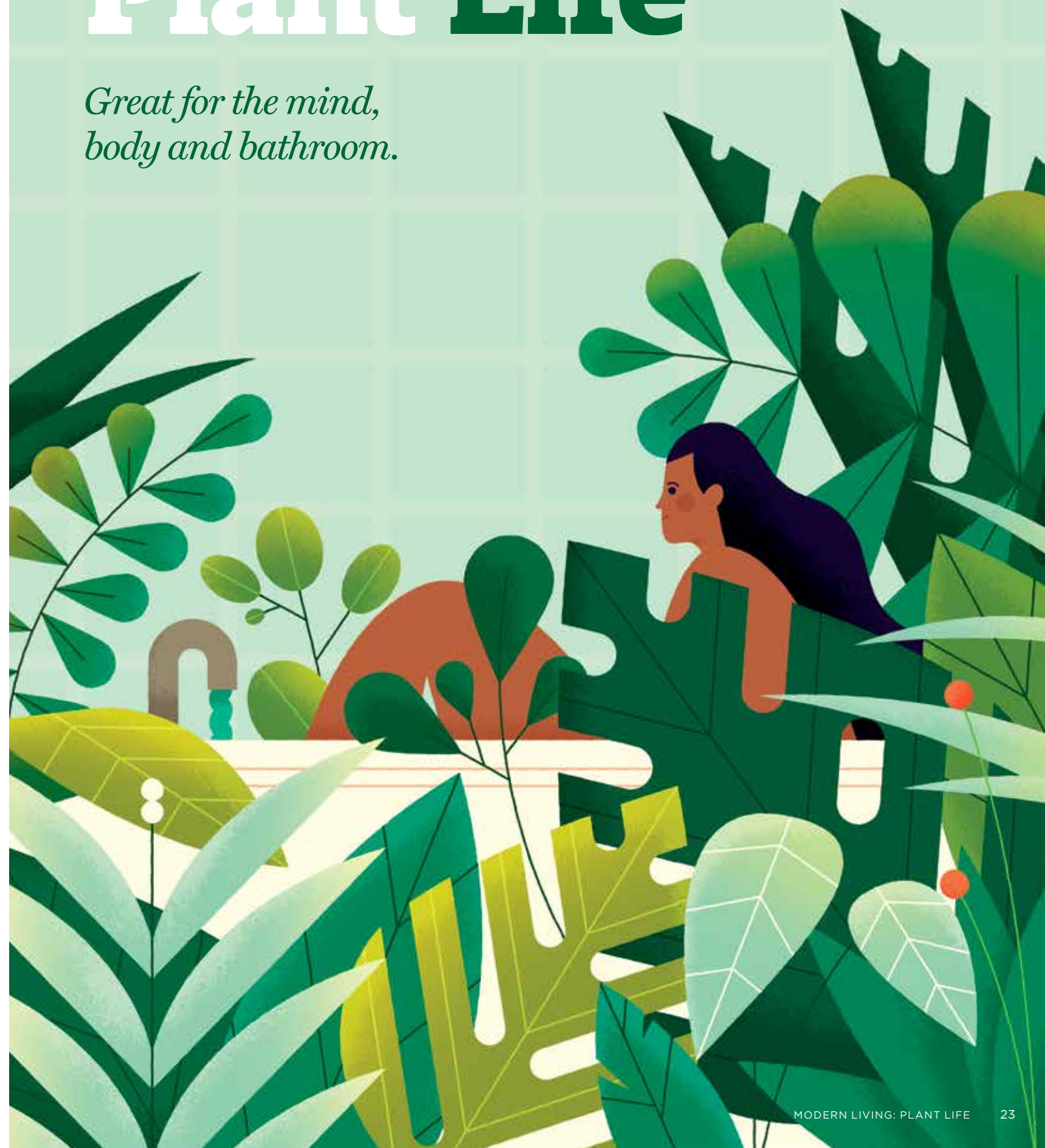

**ANTHRACITE
ACCESSORIES**

BACK IN BLACK

It started with bathroom accessories and before long the trend moved towards brassware. Now, everywhere you look you can see elements of the latest bathroom interior design trend.

Black, is most definitely back.



At Carron, we design our bath accessories to subtly compliment the bath design. Especially when it comes to our custom designed filler for models such as the Celsius Freestanding. Sometimes, however, you don't want to be subtle and you want to wear your design credentials on your sleeve

Sleek and distinctive, our Anthracite accessories add a luxurious finish to any Carron bath. Our unique process creates a durable, matt finish that makes a real statement. With the simple upgrade to our Anthracite fillers, overflow and waste fittings, your Carron bath will be at the forefront of this stylish trend.

The Carron range of Anthracite accessories will be available Winter 2020. For more details go to carronbathrooms.com





WELL BODY WELL MIND WELLBEING

Bathrooms need to be functional. That doesn't mean that they can't contribute to your overall health and wellbeing. Let us explain how.

PHOTOGRAPHY **MARK K SEAGER**

W

Work stress, news stress, family stress, life stress. The signs that we need to increase our wellbeing are all around us. Luckily, we all have a space in our homes that can provide that new found wellbeing if we just make the effort.

With a warm bath you can take the time to be present in the moment. Free your thoughts and relax your body. Be aware and allow mindfulness to take over. We rarely allow ourselves the time to be self indulgent so it helps to create an environment that encourages these feelings.

Small steps, big changes

Bathrooms can easily become sterile places. Rooms that are there to perform a function. Surrounding yourself with natural materials can subliminally boost positive emotions. Rich grained woods, natural tiles and the liberal use of plants can mimic the feeling of being outdoors and bring with it the natural endorphins that the elements provide.

Tranquil, organic colours help generate a restful vibe. With blues and greens adding to the natural, relaxing feeling.

You owe it to yourself to get the most from your bathroom and your bath. Light some candles, leave your phone in another room and use the time to rest your mind and your body.

Tranquil, organic colours help generate a restful vibe. With blues and greens adding to the natural, relaxing feeling.





“ Your bathroom doesn’t need to be just a functional place where you get in, get clean and get out. It can be your wellness sanctuary, too. ”





“ Make active steps to rest, with your bath the natural place to begin the healing. Be it with a whirlpool system or some low lighting and candles. Go on, you deserve it. ”



THE ART OF BATHING

Purify, rejuvenate, clarify and create calm.
Rediscover the Ancient Art of Relaxation
(and so much more...)

BY SUZANNE DUCKETT

The bathroom is one of the most private spaces in any home, how it looks affects its functionality and how it makes us feel and drawing a bath is a ritual in its own right. There is simply nothing like soaking in a steamy, aromatic bath to unwind both body and mind at the end of a long, hard day.

I've been using tub therapy for as long as I can remember. The ritual is addictive: the sound and sight of the tap gushing with hot, steamy water, the smell of essential oils, flickering candles, the 'do not disturb' physical and symbolic effect of that closed door, towels warming on the radiator and the feeling of stepping in and submerging into liquid love. I am not alone. Since ancient times, bathing has been equated with physical and mental health. Many cultures have created their own bathing rituals for spiritual, religious, therapeutic or social reasons. There is even a term for the practice – Balneotherapy – the treatment of disease through bathing.

While the wellness world whirs at a hundred miles an hour with the latest treatments and practices, the humble bath has stood the test of time. Baths are the ultimate equaliser and the most accessible and universal form of self-care, with the remarkable (and proven) power to instantly transform our look and feel.

This simplicity makes taking a bath more needed than ever and since time immemorial, baths have been used for their healing and revitalising properties. Cleopatra is said to have preserved her

great beauty by bathing in the milk of 700 lactating donkeys each day. Winston Churchill insisted on having two hot baths a day to de-stress from the pressures of wartime leadership and Freddie Mercury hatched the idea for 'Crazy Little Thing Called Love' while taking a dip!

Bathing is having a timely resurgence. It is a shortcut to finding peace and calm, to de-stress and be mindful. Immersion liberates the body, allowing an escape from the distractions of daily life and has consistently been shown to aid unwinding. It is, however, so much more than that and has a host of fantastic, health-boosting scientific benefits that cannot be underestimated; it can stimulate the immune system, improve sleep, help skin conditions, boost circulation and heart health, benefit muscles and joints and balance hormones. Research shows that the anti-inflammatory response, post bath, is similar to after exercising, helping to fight off infection and disease and can reduce chronic inflammation associated with illnesses like Type 2 Diabetes and even burn calories.

Everyone from A-listers to politicians are tuning into the transformative power of the daily bath. For some, they are a weekly exercise in self-indulgence and a luxurious personal ritual with twinkling candles, oils or salts and some wine. For others, a daily wash while reading is part of their wind-down schedule.

For many, having a bath is the only time they can simply shut the door on the world and be on their own; an indulgent moment of privacy and solitude.



Suzanne Duckett is a leading Wellness Journalist, Author, Speaker, Consultant and Author of *Bathe*, £16.99 (Bonnie, UK)

Follow Suzanne Duckett on Instagram
[@thisistheantidote](https://www.instagram.com/thisistheantidote)

How to draw the perfect bath...

- Have your accoutrements at the ready: reading material, your drink of choice, a candle, towel and PJs.
- Get the temperature right: water should be 36-38 °C and room temperature 25-30 °C. If necessary, heat the room beforehand so there isn't an excessive temperature difference when you step out.
- Choose your bath additive carefully – salts, muds or oils – according to mood and need (NOTE: Pregnant women or people with certain health conditions eg heart or high blood pressure, should consult their doctor before using aromatherapy oils).
- Bathe for 15-20 minutes (any longer may dry skin and put a strain on circulation) to let the bath ingredients do their magic, before slathering the best quality oil you can afford to damp skin.

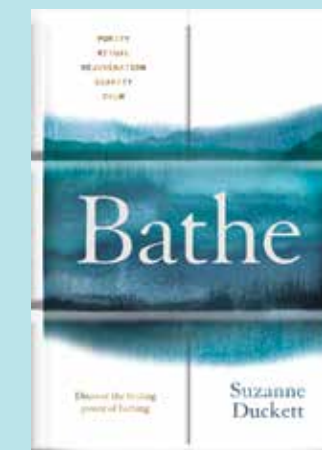

IN



If you need a bath with a small footprint, Carron could have the solution, with our selection of baths specially designed to fit into the tightest of spaces without compromising on design.

Status Showerbath

This accommodating bath has a wide base allowing for comfortable showering. It's curved corner detail also allows more access at the end of the bath for the positioning of a toilet or washbasin.

Profile DE

This is the smallest double ended bath in our range. Centred taps allow for ease of showering and bring a luxury feel but at only 1600mm wide, you get the all the functionality of a full bath in a much smaller space.

Quantum Spacesaver

Ideal for the bathroom with reduced width. The tapered design reduces the bath footprint dramatically while still allowing for a relaxing shower and bath.

Urban Sitbath

Our smallest bath by far, this agile little tub has more tricks up its sleeve than you would think. Its two level design creates a seating area if standing in the shower or getting up from the bath is an issue. At it's fullest, it still only uses 150 litres of water and it does all this while fitting in the tightest of spaces.

FITTING



Bathrooms come in all shapes and sizes and unfortunately not always the shape and size you want. We don't always have room for that dream freestanding centre piece or, as is often the case, your bath needs to be a bit of workhorse.



RELAX RELIEVE REVIVE

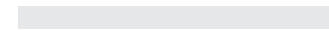

Carron's whirlpool systems offer a range of benefits to help rejuvenate weary muscles and tired minds.

Whether your goal is increased wellbeing, to relieve tired muscles after sports or exercise or just plain, self indulgent relaxation, Carron Bathrooms have a C-Lenda whirlpool system that will take your bathing to the next level.

**Quantum Integra
with Custom System A**



Why C-Lenda?

There are a number of whirlpool systems available on the market but at Carron we work with C-Lenda for a reason.

The C-Lenda Whirlpool system is the most technologically advanced system available on today's market. This unique jet system has been designed by Markon in New Zealand and ensures the most comfortable bathing experience over a wide range of settings and functions.

Almost all baths in the Carron range are compatible with this whirlpool system and are made to order and hand fitted to your specification by our skilled technicians at our factory in Falkirk.



Our Systems

System A

• 6 side jets

The 6 Flush Centro Jets give the ultimate vigorous massage with increased performance delivered due to a high air to water mix ratio. This can be controlled by the fingertip adjustable flow control.

System B

• 6 side jets, 6 back jets, 4 feet jets

In addition to the 6 Centro Jets, Flush Mini Jet clusters deliver a concentrated hydro massage to specific muscle groups including the lumbar, feet and shoulders. The ideal system for those who like to keep active, providing the right level of recovery to get you ready for the next day.

System C

• 6 side jets, 6 back jets, 4 feet jets, Chromotherapy Light

The addition of the chromotherapy light in our top-end system brings an extra level of recovery and relaxation. Chromotherapy lights aid health and harmony and can also help such conditions as Seasonal Affective Disorder (SAD). This system has all the benefits of our combined massage and recovery features with added relaxation for the mind as well as the body.

The chromotherapy light come with 11 set colours and five automatic colour cycles to help you get the most from your whirlpool. In addition, all colours can be used on their own.

• Energy Cycle

Red, Orange, Yellow, White, Yellow, Orange

• Tonic Cycle

Yellow, Red, Green

• Relax Cycle

Blue, Green, White, Green

• Sun Cycle

Yellow, Orange, Yellow, Light Blue, Yellow, White

• Dream Cycle

Green, Blue, Light Blue, White, Orange, Red, Violet

The chromotherapy light is also available on its own or as an addition to any system.

Features as standard:

- All parts made from tough and corrosion resistant chrome plastic
- Flush, surface jets for comfortable bathing and easy cleaning
- Full 2 year parts and labour warranty

Safety Flush Function:

The flush suction is the safety grill where water is drawn from the bath into the pump. It has a unique built in safety feature which disengages the water pressure instantly. If the safety grill is blocked for any reason the bath will automatically disengage the water pressure instantly upon activation.

Function control:

All our systems come with an option for pneumatic or electronic controls.

All systems are made to order:

Please check with your supplier or Carron Bathrooms before ordering.

Status Bath with System C

Chromotherapy Light

6 Back Jets

6 Side Jets

4 Feet Jets

After years of watching elite athletes shiver in ice baths, new research has revealed that a warm bath is better at helping recovery following exercise than a cold one. So, is hot the new cold?



01

The Warm up

While we often think about muscle recovery after our workout, The Journal of Strength and Conditioning Research has found that it is just as important to make sure the muscles are warmed up beforehand. A hot bath, combined with stretching, before a run or workout can help loosen tight muscles and help prevent further injury during exercise.

02

Warm down, don't cool off

A hot bath, around 32 to 38 degrees centigrade, will help the blood circulate around the muscles and joints and help the muscles grow after a workout. Ice baths have the opposite effect and can limit the muscle growth you worked so hard to get during the workout.

04

Soak it all in

If you have worked hard, you deserve a reward and a long bath could be what you need. And it's not just about your body recuperating, it will allow the mind to recover as well. Using the chromotherapy lights in our C-Lenda systems aids health and harmony as well as tackling such conditions as Seasonal Affective Disorder (SAD).

03

Turn on the jets

After a tough workout it is important to relieve the stress the body has been put under. The addition of a C-Lenda whirlpool system can really optimise recovery. This can prevent elastic tissue damage and has been found to reduce Myoglobin, a protein your muscles release after muscle damage.

05

Rest up

It is always important not to overexert yourself and rest to allow your body to fully recuperate. A before bed can also help you sleep better. According to Cornell Medical School a minimum of 20 minutes in the hot bath before bed will help you get a deeper sleep throughout the night, to wake up fresh the next day, ready to go again.



BATHING GUIDE:

TOP 5 TIPS FOR

Sport Relief





LAINGS

FROM ONE FAMILY TO THE NEXT, SINCE 1862

Formed in 1862, Laings is now the oldest business in Inverurie, Aberdeenshire. It began life as a plumbing company and expanded its services over the decades and generations until the early 1980's when Andrew Walker suggested they start supplying their own bathrooms instead of relying on merchants. From here, office space was converted into showroom space and the business continued its expansion.

The conversion from office to showroom gathered pace throughout the 80's as the bathroom installation business grew and Laings started supplying and fitting kitchens in the early 90's. By 1994, the company had outgrown its premises which inspired the move to where the business is today. With a showroom covering 14,000 sq ft, Laings offers luxury bathrooms, kitchens and bedrooms to both commercial and retail clients.



Darren Walker
Director
Tel: 01467 620 311
info@laings.co.uk

Q. How did it you get into the bathroom installation trade?

A. Three generations of the Laing family ran the business before it was passed on to my father, Andy, now the Managing Director. It is now run by the Walker family with my sisters, uncles and even brother-in-law involved so it still is very much a family business. The family at the helm may have changed but the Laing name has stayed.

Q. What areas do you specialise in?

A. Although we have a 60/40 split in terms of retail and commercial projects, we don't see ourselves as specialising in one area. We have our specialist teams that focus on different areas of the business – those that focus on home bathroom, kitchen and bedroom projects, and those which cater for larger, commercial projects like hotels and housing developments. We really do offer something for everyone.

Q. What do you think makes Laings unique?

A. It has to be the full range of design and installation services we offer to our retail and commercial customers at every price point. For large contracts including hotel projects and homebuilders, we offer a full turnkey service through our dedicated contracts division, while our flagship Laings brand delivers a luxury design and installation experience for our core retail customer base and Laings Directline provides quality, affordable kitchens and bathrooms for retail customers and our Trade Members.

“
We never stop improving and continually use customer feedback and industry research to ensure our customers have the best experience possible.
”

We complete a large number of projects in the Highlands and Islands so it can be challenging when you are battling the elements as well as the clock to get the job finished on time.

We're just as proud of the commercial projects as we are of the domestic jobs. Every customer is important to us so we are proud of it all.

Q. You are know for your award winning showrooms. What's your approach?

A. We've been lucky enough to win the kbbreview Bathroom Showroom of the Year Award in 2017 and Bathroom Retailer of the Year Award, 2018. We also won two awards with the Aberdeen Chamber of Commerce which was a great honour, too.

We never stop improving and continually use customer feedback and industry research to ensure our customers have the best experience possible. It's important to make sure they never feel under pressure and the showroom has enough space for them to feel comfortable.

To mark the 25th anniversary of our current showroom we refurbished the building inside and out. The building was re-clad and the car park was re-tarmacked as well. A new entrance was also fitted to ensure a positive first impression.

The customer experience is very important and we have over 100 displays that are continually refreshed to make sure they are as up to date as possible. When it comes to the customer, our work is never done. We are always moving on and improving what we offer.



Q. How does this approach reflect in the companies you work with and your relationship with Carron Bathrooms?

A. We have to have full confidence in the brands we work with. This involves everything from the product suitability, service and delivery options and the after-sales support as well. We have very little need for that support from Carron but when we do, there are no issues. Their dedication to customer service matches ours.

We have been working with Carron for a number of years and would have no problem recommending them to not only our customers but other businesses as well.

Q. Finally what tips would you give people who are planning a bathroom re-furb?

A. Refurbishing your bathroom is quite an investment and not a project you want to cut corners on. Being honest about your budget is very important as it allows you to get the best value for money and the more information you can give a company like Laings, the better. This gives us the chance to recommend the right products, specification and layout for your bathroom.

Many people try to save money here and there but when you think about what could go wrong and what it would cost to fix, it's not worth it. Getting professional advice and speaking to an experienced designer is the best way to ensure your completed room will give you years of joy.



FAQs

CLEANING YOUR BATH

One of the most common requests we receive from customers is the best way to take care of their new bath. Cleaning a bath may seem straightforward but if you follow our simple cleaning guide, you can guarantee your Carron bath will look as good as the day it was installed.



BATH FAQs

1

Cleaning should be done immediately after use, whilst the bath is still warm. This way, the layer of insoluble soap, grease and dirt which would otherwise harden on the surface can be removed more easily.

2



We recommend simply using a small amount of mild detergent, or a bathroom cleaner such as CIF Cream Cleaner.

3



Avoid leaving lit cigarettes or any other heat source on or near the surface of the bath.

4



After cleaning, rinse thoroughly with clean water.

5

Do not bring into contact with sharp edges. Pointed objects could scratch the bath surface.

6

Each time after use, clean the bath thoroughly with warm soapy water.

7

In areas with particularly hard water, insoluble calcium salts may form deposits on the taps and along the water line. In order to avoid these, clean the bath with a soft sponge and detergent in hot water immediately after use. Rinse with plenty of cold water.

8



Warning: abrasive powder cleaners may scratch the surface of your bath.

SCANDI STYLE

Interior trends come and go but certain styles endure. And the Scandinavian aesthetic is one that has stood the test of time.









“Permanent fixtures can be understated yet well designed and full of purpose while interest is brought from accessories, towels, rugs and plants.”



Getting the Look



 <p>Alana Round Mirror, Brass Made.com</p>	 <p>Cement Bathroom Set Zara.com</p>	 <p>Waffle Towels, Mustard Made.com</p>
 <p>Wood Herringbone Laminate Flooring diy.com</p>	 <p>Bamboo Towel Rail Habitat.com</p>	 <p>Grey Concrete Washbasin tikamoon.co.uk</p>

Maybe it's the simplicity combined with utility or the understated beauty of the clean lines that create the lasting appeal, but the Scandinavian interior design style is an ideal choice for the bathroom.

Permanent fixtures can be understated yet well designed and full of purpose while interest is brought from accessories, towels, rugs and plants. These all bring subtle colour and provide enough of a contrast

against crisp, painted walls and natural wood floors.

Storage is an important element to consider. Part of the appeal is the minimalist approach and this is hard to achieve if the room is cluttered with wet towels and empty shampoo bottles. Invest in a linen basket for clothes and towels and soap dispensers that compliment the interior to help keep things on style, tidy and calm and you'll be bathing in a Scandi paradise before you know it.

Keep it neutral

The Scandinavian style approach is best used with a neutral colour palette. Many of the colours used in the bathroom should come from the natural materials you use such as wood and stone. To add interest, accent colours can be used but do so sparingly.

Making a splash in the industry

Alan Gape at SpaSplash is known in the industry for his specialist hydrotherapy whirlpool systems but it is his interesting back-story that taught him so much about the powerful benefits of water.

Q. Alan, how did you end up working with whirlpool baths?

A. Well, originally I was an apprentice electro-mechanical engineer in the Royal Navy. Learning my trade while refurbishing battleships. But I didn't stay the distance as I got quite bored so I joined the Royal Air Force - I didn't want to join the Army as I would get sent to Northern Ireland and I didn't want to stay in the Navy as I get seasick! It was my work with Air Force navigational instruments that gave me the insight to manufacture the micro-jet. Although I didn't know it at the time obviously.

I ended up spending three years in Northern Ireland maintaining helicopters so my plan didn't work. I also worked with a NATO task force that involved getting on transport ships such as RFA Sir Galahad, later sunk in the Falklands war, travelling in force nine gales so I wasn't very happy about that.

When I left the Air Force I ended up getting a job in a swimming pool maintenance company, purely because I

knew more about their equipment than their Managing Director. Before long I was working for myself, with a van borrowed from a friend, running my own maintenance company.

Over time, I began working with whirlpool systems and on a trip to California in 1981, via a contact in the industry, managed to get a tour of the Purex factory and a conversation about problems with loose pipes took me to a specialist who told me about heat forming pipes. This changed the way I fitted the systems from then on.

Q. How did you begin specialising in the health benefits of the systems?

A. I spent some time working with the Air Force again, helping them develop a special bath that would help safely revive pilots that had crashed into icy waters. I also worked with the Olympic gold medal sprinter, Alan Wells, who obviously needed to build strength but also recover from the training. To combat the effects of lactic

This experience has led me to working with other athletes and people from all walks of life who need the benefits of a whirlpool bath.



acid on the muscles we developed a system that would run at a lower temperature and deliver a massage that would break down the lactic acid.

This experience has led me to working with other athletes and people from all walks of life who need the benefits of a whirlpool bath. We've built systems that have helped people suffering from varicose veins to unique systems for children that require 24 hour care to help stimulate the muscles that would not normally get any other stimulation.

We have one customer that is disabled from the shoulders down. Working with her, we created not only a bespoke system that helps with her condition, but we took a Carron bath (naturally!) and fitted it to the wall so it now also accommodates the hoist that helps her in and out of the tub.

Q. Finally, what tips would you give the average customer who is planning a whirlpool bath purchase?

A. Whatever you go for, back neck and shoulder jets I would say are essential. The back jets are 70% of the benefit of having a whirlpool system. If you went for a massage, where would they concentrate? Either side of the spine, across the shoulders and up the neck. Feet jets are also very beneficial due to the number of nerve endings in the feet.

If you are looking at a custom system, you have to think about what benefits you want to gain from hydrotherapy. Runners and cyclists would be wise to get jets that run the length of their legs, helping to break down the lactic acid.

We don't focus on entry level systems - if you got a massage and they rubbed down either side of your body and sent you on your way, would you go back? No. But if you got a proper massage, you'd go back. And that is what we deliver at SpaSplash, systems that make a difference.

spasplash.co.uk



Bathrooms need to be practical and reliable but that doesn't mean they need to be boring. With our unique ColourMatch service you can choose a colour, any colour, and Carron will match your panel to your bathroom design to help add that personal touch.

This design solution adapts to the changing world of design. Giving you the choice of colour for your freestanding base, with a system so flexible, it can be matched to a paint swatch.



ColourMatch Infinity base

To complement this feature, the unique Infinity Base is designed to turn our most popular 1700x750 models into a freestanding bath. Bringing together the flexibility of our standard rectangular range, the luxury of a freestanding and the added style statement of ColourMatch, all in one.

ColourMatch service available on certain models only. For further details please visit www.carronbathrooms.com/colourmatch

ColourMatch

There's a Carron bath for every style of bathrooms and with ColourMatch, there's a colour for every style, too.



THE
ENDURING
LEGACY
OF

Carron

*260 years after
the first blast of the
furnace at the Carron
Company on the
1st of January 1760,
intrigue into Carron
still burns brightly.*

The Heritage Lottery funded project Great Place Scheme recently worked with the Falkirk Community Trust's Hidden Heritage project to uncover more about the history of industry in Falkirk. The town that housed the famous Carron Ironworks, an integral part in Britain's industrial heritage.

There has always been a fascination with Carron, one which has continued throughout the centuries. In the early days it attracted famous figures such as US founding father Benjamin Franklin and celebrated poet Robert Burns, both visiting the works on the shores of the river Carron.

Well into the 20th Century, the Carron Ironworks was still a place of interest and wonder for thousands across the nation. In 1956, the BBC travelled to Carron and its documentary, Bath Night, attracted 8 million viewers from across the nation, all tuning in to watch the process of bath manufacturing at the legendary works.

While much is known about products such as the Carronade cannons, the telephone and pillar boxes and of course the baths produced at the works, Hidden Heritage has delved into the wider area which the Carron Company helped to build up, and the lives of its workers.

From the dams that powered the works to the houses they provided for the employees from the end of the 18th to the beginning of the 19th century, Carron helped attract and retain workers. Forge Row, which was dedicated to management and clerical workers was devised to attract skilled workers from across Britain.

All sections of the workforce benefited from the housing, however, which including Nailers' Row, and West Carron, which housed the labourers, were key to producing the products for which Carron is famed. And while pretty much all the housing has been lost, with the efforts of the project volunteers, more information on the area has been unearthed that was previously thought to be lost.

The legacy of Carron's past is not just one of innovation and quality products, it is as much about the communities that built their lives around these works. A sense of pride is still held by those who lived and worked at Carron. A legacy which we will always endeavour to maintain at Carron Bathrooms.

Now, in the 21st century, the results of the Hidden Heritage project's hard work will be used for the 'Carron Digital Trail'. Delivered through a digital app, the trail will provide a guide for people touring and walking the area, filled with stories of the Carron works and the people that kept its fires burning.

While much of the local area has changed, the tour will still give those a sense of what living in Carron in yesteryear may have been like. Encompassing the famous clock tower, still guarded by two Carronades, the Carron Dams reservoir which is now a picturesque nature reserve, and our factory at Carron Bathrooms, the walking tour will be able to tell the story of the original works, founded all the way back in 1759. And hopefully, keep the intrigue alive.

*In the early days
it attracted famous
figures such as
US founding father
Benjamin Franklin
and celebrated poet
Robert Burns, both
visiting the works
on the shores of the
river Carron.*



Carronite™

They say still waters run deep and when you opt for the Carronite™ finish for your Carron bath, it's what you can't see that makes all the difference.

Carronite™ is Carron Bathrooms' unique, market leading finishing system which not only adds to your bathing experience but has a range of features that can benefit your pocket and the environment.

STRENGTH OF CARRONITE™



STRONGER

It's our unique process that creates the added strength found in all Carronite™ baths. A stronger bath is a more rigid bath, resulting in a more solid experience when bathing or showering.



WARMER FOR LONGER

Due to the extra finishing layers, Carronite™ baths are able to keep water temperature levels hotter for longer. Up to thirty minutes longer in some tests.



PEACE OF MIND

We are so confident in the quality and finish of our Carronite™ baths that we give every bath a 30 year guarantee. That's because Carronite™ baths are designed to last a lifetime.

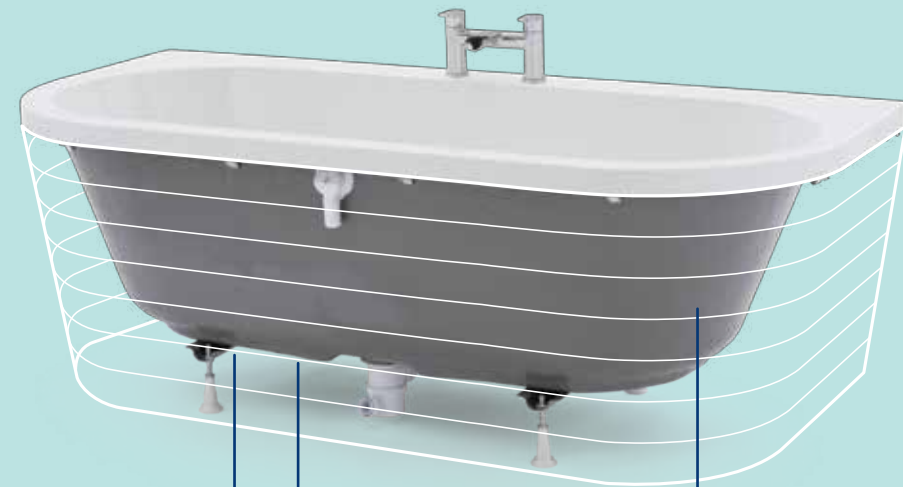

THE SUPPORT

Created specifically for the Carronite™ Baseboard, this unique frame, and foot set uses the added weight and thickness of our baths to deliver additional stability and security.

THE BASEBOARD

Custom baseboards, cut to size for each Carronite™ model, are applied by hand before the Carronite™ finish is applied.

THE FINISH

Specially formulated, our unique Carronite™ finish results in increased rigidity while the density of the material allows greater heat retaining properties.

CARRONITE™ FAQs

1



STRONGER

The increased strength delivered by the Carronite™ finish results in a stronger, more rigid bath. No more creaking when having a shower and a feeling of luxury and security when having a long soak.

2



BETTER FOR THE ENVIRONMENT

When a full bath keeps it's heat for longer there's less need to top it up with hot water. That's better for your gas bill and the environment.

3



PROFESSIONAL CHOICE

Plumbers and fitters need a job to go smoothly and the last thing they need is to return to a customer because of problems. Carronite™ baths are the choice of the professional because their consistent quality is something that professionals can rely on.

4

WARMER FOR LONGER

Due to the extra finishing layers, Carronite™ baths are able to keep water temperature levels hotter for longer. Up to thirty minutes longer in some tests.

5



30 YEAR GUARANTEE

What speaks volumes about the benefits of the product is Carron's willingness to back their unique process with a 30 year guarantee on all Carronite™ baths.



Product Range

What makes the Carron Bathrooms Product Range unique is the vast range of bath options available. Every one built then finished by hand to reach our highest levels of quality and conformity.

And we constantly listen to our customers in the trade. This way we can continue to expand our range to not only feature new bath designs and concepts, but also size options for each range.

Every bathroom fit-out is unique and we aim to ensure there is the right bath for every customers' needs.

Rectangular Baths



Alpha

LENGTH X WIDTH	HEIGHT	DEPTH	CAPACITY
1700 x 700mm	515mm	400mm	160 Litres
1700 x 750mm	540mm	425mm	175 Litres
1800 x 800mm	540mm	440mm	220 Litres



Apex

FEATURES:

LENGTH X WIDTH	HEIGHT	DEPTH	CAPACITY
1700 x 800mm	540mm	430mm	210 Litres



Arc

FEATURES:

LENGTH X WIDTH	HEIGHT	DEPTH	CAPACITY
1500 x 700mm	515mm	400mm	150 Litres
1700 x 700mm	515mm	400mm	172 Litres
1700 x 750mm	540mm	420mm	195 Litres



Arc Duo

LENGTH X WIDTH	HEIGHT	DEPTH	CAPACITY
1700 x 750mm	540mm	420mm	190 Litres
1800 x 800mm	540mm	430mm	210 Litres



Axis

FEATURES:

LENGTH X WIDTH	HEIGHT	DEPTH	CAPACITY
1500 x 700mm	430mm	345mm	131 Litres
1600 x 700mm	430mm	345mm	138 Litres
1650 x 700mm	430mm	345mm	142 Litres
1700 x 700mm	430mm	345mm	145 Litres



Britannia

FEATURES:

LENGTH X WIDTH	HEIGHT	DEPTH	CAPACITY
1700 x 700mm	515mm	370mm	155 Litres
1700 x 750mm	540mm	460mm	210 Litres
1800 x 800mm	540mm	430mm	245 Litres



Camden

FEATURES:

LENGTH X WIDTH	HEIGHT	DEPTH	CAPACITY
1600 x 700mm	515mm	405mm	192 Litres
1650 x 700mm	515mm	400mm	200 Litres
1700 x 700mm	515mm	405mm	209 Litres



Delta

FEATURES:

LENGTH X WIDTH	HEIGHT	DEPTH	CAPACITY
1400 x 700mm	515mm	410mm	142 Litres
1500 x 700mm	515mm	410mm	152 Litres
1600 x 700mm	515mm	410mm	162 Litres
1650 x 700mm	515mm	410mm	167 Litres
1675 x 700mm	515mm	410mm	170 Litres
1700 x 700mm	515mm	410mm	170 Litres



Echelon (inc filler)

LENGTH X WIDTH	HEIGHT	DEPTH	CAPACITY
1700 x 750mm	540mm	420mm	209 Litres
1800 x 800mm	540mm	440mm	230 Litres



Equation

LENGTH X WIDTH	HEIGHT	DEPTH	CAPACITY
1700 x 750mm	540mm	420mm	205 Litres
1800 x 800mm	540mm	430mm	233 Litres



Equity

LENGTH X WIDTH	HEIGHT	DEPTH	CAPACITY
1700 x 750mm	540mm	420mm	204 Litres
1800 x 800mm	540mm	440mm	225 Litres

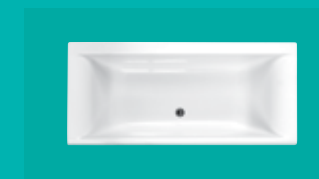

Haiku

LENGTH X WIDTH	HEIGHT	DEPTH	CAPACITY
1700 x 800mm	540mm	450mm	220 Litres
1800 x 800mm	540mm	450mm	230 Litres
1800 x 900mm	540mm	450mm	290 Litres



Highgate Duo

FEATURES:

LENGTH X WIDTH	HEIGHT	DEPTH	CAPACITY
1700 x 750mm	540mm	430mm	210 Litres
1800 x 800mm	540mm	430mm	264 Litres



Highgate SE

FEATURES:

LENGTH X WIDTH	HEIGHT	DEPTH	CAPACITY
1700 x 750mm	540mm	420mm	216 Litres
1800 x 800mm	540mm	430mm	268 Litres



Index

FEATURES:

LENGTH X WIDTH	HEIGHT	DEPTH	CAPACITY
1700 x 750mm	540mm	430mm	195 Litres



Imperial TG

FEATURES:

LENGTH X WIDTH	HEIGHT	DEPTH	CAPACITY
1400 x 700mm	515mm	400mm	135 Litres
1500 x 700mm	515mm	400mm	145 Litres
1600 x 700mm	515mm	400mm	162 Litres
1675 x 700mm	515mm	400mm	180 Litres
1700 x 700mm	515mm	400mm	180 Litres
1800 x 750mm	540mm	420mm	210 Litres

Rectangular Baths



Linea

LENGTH x WIDTH	HEIGHT	DEPTH	CAPACITY
1900 x 900mm	570mm	460mm	345 Litres



Mistral

LENGTH x WIDTH	HEIGHT	DEPTH	CAPACITY
1800 x 700-900mm	570mm	480mm	330 Litres



Matrix

FEATURES:

LENGTH x WIDTH	HEIGHT	DEPTH	CAPACITY
1500 x 700mm	515mm	345mm	131 Litres
1600 x 700mm	515mm	345mm	138 Litres
1650 x 700mm	515mm	345mm	142 Litres
1700 x 700mm	515mm	345mm	145 Litres



Profile

FEATURES:

LENGTH x WIDTH	HEIGHT	DEPTH	CAPACITY
1500 x 700mm	515mm	400mm	190 Litres
1600 x 700mm	515mm	400mm	204 Litres
1700 x 700mm	515mm	400mm	218 Litres
1700 x 750mm	540mm	430mm	257 Litres
1750 x 750mm	540mm	410mm	264 Litres
1800 x 700mm	540mm	400mm	255 Litres



Profile Duo

FEATURES:

LENGTH x WIDTH	HEIGHT	DEPTH	CAPACITY
1600 x 700mm	515mm	410mm	188 Litres
1600 x 800mm	540mm	410mm	215 Litres
1650 x 700mm	515mm	410mm	196 Litres
1700 x 700mm	515mm	410mm	205 Litres
1700 x 750mm	540mm	410mm	230 Litres
1750 x 850mm	540mm	410mm	236 Litres
1800 x 700mm	540mm	410mm	231 Litres



Quantum Duo

FEATURES:

LENGTH x WIDTH	HEIGHT	DEPTH	CAPACITY
1700 x 700mm	515mm	410mm	165 Litres
1700 x 750mm	540mm	430mm	190 Litres
1700 x 800mm	540mm	440mm	200 Litres
1800 x 800mm	540mm	440mm	230 Litres
1900 x 900mm	570mm	450mm	350 Litres



Quantum Integra

FEATURES:

LENGTH x WIDTH	HEIGHT	DEPTH	CAPACITY
1500 x 700mm	515mm	410mm	198 Litres
1600 x 700mm	515mm	410mm	213 Litres
1650 x 700mm	515mm	410mm	216 Litres
1700 x 700mm	515mm	410mm	228 Litres
1700 x 750mm	540mm	430mm	240 Litres
1700 x 800mm	540mm	440mm	267 Litres
1750 x 750mm	540mm	430mm	247 Litres
1800 x 800mm	540mm	440mm	285 Litres



Quantum Integra Eco

FEATURES:

LENGTH x WIDTH	HEIGHT	DEPTH	CAPACITY
1500 x 700mm	430mm	345mm	152 Litres
1500 x 700mm	515mm	345mm	152 Litres
1600 x 700mm	430mm	345mm	165 Litres
1600 x 700mm	515mm	345mm	165 Litres
1700 x 700mm	430mm	345mm	174 Litres
1700 x 700mm	515mm	345mm	174 Litres



Quantum Spacesaver

FEATURES:

LENGTH x WIDTH	HEIGHT	DEPTH	CAPACITY
1700 x 400-750mm	540mm	420mm	211 Litres

Available in right hand or left hand. Right hand shown.



Quantum SE

FEATURES:

LENGTH x WIDTH	HEIGHT	DEPTH	CAPACITY
1500 x 700mm	515mm	410mm	198 Litres
1600 x 700mm	515mm	410mm	213 Litres
1600 x 800mm	540mm	430mm	247 Litres
1700 x 700mm	515mm	410mm	228 Litres
1700 x 750mm	540mm	430mm	240 Litres
1700 x 800mm	540mm	440mm	267 Litres

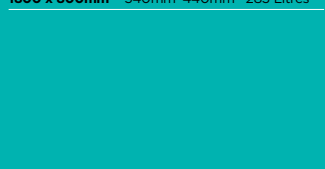

Status

FEATURES:

LENGTH x WIDTH	HEIGHT	DEPTH	CAPACITY
1600 x 725mm	540mm	425mm	197 Litres
1700 x 725mm	540mm	425mm	205 Litres
1700 x 800mm	540mm	450mm	250 Litres

Available in right hand or left hand. Right hand shown.



Sigma

FEATURES:

LENGTH x WIDTH	HEIGHT	DEPTH	CAPACITY
1600 x 750mm	540mm	420mm	175 Litres
1700 x 750mm	540mm	440mm	195 Litres
1700 x 800mm	540mm	450mm	220 Litres
1800 x 800mm	540mm	450mm	240 Litres
1900 x 900mm	570mm	460mm	350 Litres



Swallow TG

FEATURES:

LENGTH x WIDTH	HEIGHT	DEPTH	CAPACITY
1700 x 700mm	515mm	370mm	182 Litres
1800 x 700mm	540mm	365mm	185 Litres



Urban

FEATURES:

LENGTH x WIDTH	HEIGHT	DEPTH	CAPACITY
1700 x 725mm	540mm	410mm	224 Litres



Urban Sitbath

LENGTH x WIDTH	HEIGHT	DEPTH	CAPACITY
1250 x 725mm	540mm	450mm	155 Litres

Depth at deepest point.

Showerbaths



Arc

FEATURES:

LENGTH x WIDTH	HEIGHT	DEPTH	CAPACITY
1700 x 700-850mm	540mm	430mm	250 Litres

Available in right hand or left hand. Left hand shown.



Aspect

FEATURES:

LENGTH x WIDTH	HEIGHT	DEPTH	CAPACITY
1700 x 700-800mm	430mm	345mm	190 Litres

Available in right hand or left hand. Left hand shown.



Delta

FEATURES:

LENGTH x WIDTH	HEIGHT	DEPTH	CAPACITY
1600 x 700-800mm	540mm	410mm	210 Litres
1700 x 700-800mm	540mm	420mm	230 Litres

Available in right hand or left hand. Left hand shown.



Highgate Showerbath

FEATURES:

LENGTH x WIDTH	HEIGHT	DEPTH	CAPACITY
1700 x 750-900mm	540mm	430mm	272 Litres

Available in right hand or left hand. Left hand shown.



Profile Showerbath

FEATURES:

LENGTH x WIDTH	HEIGHT	DEPTH	CAPACITY
1500 x 900mm	540mm	440mm	241 Litres

Available in right hand or left hand. Left hand shown. Not suitable to be recessed.



Quantum

FEATURES:

LENGTH x WIDTH	HEIGHT	DEPTH	CAPACITY
1500 x 700-850mm	540mm	420mm	229 Litres
1600 x 700-850mm	540mm	420mm	250 Litres
1700 x 700-850mm	540mm	420mm	265 Litres

Available in right hand or left hand. Left hand shown.



Status Showerbath

FEATURES:

LENGTH x WIDTH	HEIGHT	DEPTH	CAPACITY
1550 x 850mm	540mm	450mm	262 Litres

Available in right hand or left hand. Right hand shown.



Sigma

FEATURES:

LENGTH x WIDTH	HEIGHT	DEPTH	CAPACITY
1800 x 750-900mm	540mm	450mm	265 Litres

Available in right hand or left hand. Left hand shown.



Urban Compact

FEATURES:

LENGTH x WIDTH	HEIGHT	DEPTH	CAPACITY
1500 x 750-900mm	540mm	420mm	228 Litres

Available in right hand or left hand. Left hand shown.



Urban

FEATURES:

LENGTH x WIDTH	HEIGHT	DEPTH	CAPACITY
1700 x 750-900mm	540mm	420mm	260 Litres

Available in right hand or left hand. Left hand shown.



Urban edge

FEATURES:

LENGTH x WIDTH	HEIGHT	DEPTH	CAPACITY
1575 x 700-850mm	540mm	420mm	225 Litres
1675 x 700-850mm	540mm	420mm	245 Litres

Available in right hand or left hand. Left hand shown.



Urban swing

FEATURES:

LENGTH x WIDTH	HEIGHT	DEPTH	CAPACITY
1575 x 850mm	540mm	420mm	225 Litres

Available in right hand or left hand. Left hand shown.

Freestanding Baths



Ascoli

LENGTH X WIDTH HEIGHT DEPTH CAPACITY
1700 x 750mm 650mm 480mm 247 Litres

Inset option available.



Celsius

LENGTH X WIDTH HEIGHT DEPTH CAPACITY
1910 x 910mm 610mm 450mm 330 Litres

Includes Filler.



Elysee

LENGTH X WIDTH HEIGHT DEPTH CAPACITY
1800 x 900mm 650mm 480mm 330 Litres

Inset option available.



Halcyon D

LENGTH X WIDTH HEIGHT DEPTH CAPACITY
1750 x 800mm 540mm 450mm 253 Litres

Features: Back to Wall, Detachable Panel



Halcyon Oval

LENGTH X WIDTH HEIGHT DEPTH CAPACITY
1750 x 800mm 610mm 450mm 270 Litres

Inset option available.



Halcyon Square

LENGTH X WIDTH HEIGHT DEPTH CAPACITY
1750 x 800mm 600mm 440mm 286 Litres

Inset option available.



Highgate Freestanding

LENGTH X WIDTH HEIGHT DEPTH CAPACITY
1750 x 800mm 620mm 440mm 265 Litres



Paradigm

LENGTH X WIDTH HEIGHT DEPTH CAPACITY
1550 x 850mm 620-660mm 480mm 238 Litres

Bath Features Key

Baths arranged alphabetically by family. All dimensions shown are in millimetres and capacity in litres.

- Suitable for Showering
- Handgrip option available
- Water saver
- Ease of access

Grip Options

Chrome handgrips available on rectangular baths with the Handgrip icon . Please order using appropriate product code.



CCG-1 Chrome Handgrip
Delta, Sigma

CCG-2 Chrome Handgrip
Axis, Matrix, Index, Apex, Arc

Corner Baths

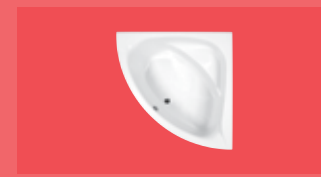

Centennial

LENGTH X WIDTH HEIGHT DEPTH CAPACITY
1500 x 1500mm 570mm 495mm 407 Litres

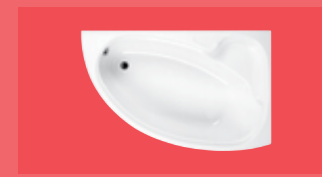

Dove

LENGTH X WIDTH HEIGHT DEPTH CAPACITY
1550 x 950mm 540mm 400mm 190 Litres

Available in right hand or left hand. Left hand shown.

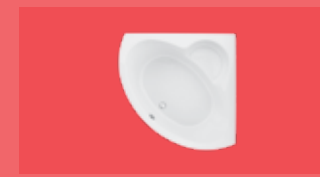

Monarch

LENGTH X WIDTH HEIGHT DEPTH CAPACITY
1300 x 1300mm 540mm 400mm 235 Litres



Omega

LENGTH X WIDTH HEIGHT DEPTH CAPACITY
1700 x 1000mm 540mm 445mm 255 Litres

Available in right hand or left hand. Left hand shown.

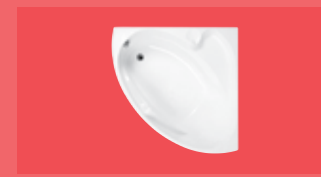

Oriole

LENGTH X WIDTH HEIGHT DEPTH CAPACITY
1200 x 1200mm 540mm 400mm 190 Litres

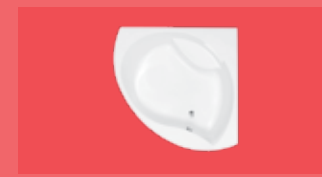

Tranquility

LENGTH X WIDTH HEIGHT DEPTH CAPACITY
1300 x 1300mm 540mm 450mm 295 Litres



Clipper

LENGTH X WIDTH HEIGHT DEPTH CAPACITY
1200 x 1575mm 580mm 475mm 335 Litres

Available in right hand or left hand. Left hand shown.

Celsius Range



Celsius

FEATURES:

LENGTH X WIDTH HEIGHT DEPTH CAPACITY
1700 x 700mm 540mm 430mm 265 Litres
1700 x 750mm 540mm 450mm 275 Litres

Available in right hand or left hand. Right hand shown.



Celsius 1800

LENGTH X WIDTH HEIGHT DEPTH CAPACITY
1800 x 800mm 540mm 450mm 300 Litres



Celsius Duo

LENGTH X WIDTH HEIGHT DEPTH CAPACITY
2000 x 1400mm 570mm 480mm 560 Litres



Celsius Oval

LENGTH X WIDTH HEIGHT DEPTH CAPACITY
1900 x 1000mm 570mm 470mm 320 Litres



Celsius Showerbath

FEATURES:

LENGTH X WIDTH HEIGHT DEPTH CAPACITY
1700 x 750-900mm 540mm 450mm 305 Litres

Available in right hand or left hand. Left hand shown.

PRODUCT FOCUS:

ISHGA ORGANIC SEAWEED SKINCARE



Nature Skincare Body Wash, Shampoo & Conditioner

All 250ML

An uplifting body wash with an organic Coconut Oil base packed with essential fatty acids to hydrate and nourish the skin. A natural shampoo with a detoxing plant derived base which thoroughly, but gently, cleanses your hair and scalp, with added Aloe Vera to strengthen and soothe. And a conditioner with an intensely moisturising base combining the oils of Jojoba, Olive and Sunflower with Shea Butter and Vitamin E to gently hydrate, nourish and repair damaged or dry hair. All with the natural benefits of organic, Hebridean seaweed.

Hebridean Dreams Hand Poured Seaweed Candle

30CL

Made from soya wax and hand poured in 2 stages with a sprinkle of hand-harvested Hebridean seaweed in between in each pour. The seaweed becomes apparent when the candle is lit and the top layer of wax becomes molten.



Replenishing Organic Lip Balm

15ML

This replenishing lip balm contains a rich moisturising base of shea butter and is made from high quality, organic ingredients. With a light SPF to give daily defence against UV and sun damage.



Invigorating Organic Body Lotion

100ML

This invigorating Body Lotion contains a potent combination of Antioxidants, including Vitamins A, C and E; with Trace Elements, Minerals and Amino Acids. As well as ishga's unique seaweed extract which features the benefits of both Fucus Serratus and Fucus Vesiculosus.



The name ishga is derived from the Gaelic word for water.

The Western Isles have some of the cleanest waters in the world and this is where we sustainably hand-harvest our seaweed to produce the 100% organic ingredient for our skincare range. Scientific tests have shown that Hebridean seaweed contains natural anti-oxidants with anti-ageing properties which help protect the skin.

As a result of our unique processes, the seaweed content in our products is extremely high. By harnessing the potent powers of the finest Scottish seaweed, ishga products work on every skin type. All the while, making a positive difference to the health and appearance of your skin.

Available online at ishga.com



With bathing, the immersion of the body in water is a primitive feeling and one that reinvigorates the body, mind and soul.



THE NAME
FOR BATHS

PROUD MEMBER OF:

